

BX Series

Terminal type photoelectric sensor for long distance

■ Features

- Built-in sensitivity adjuster
- Timer : ON Delay, OFF Delay, One-shot Delay
- NPN/PNP open collector output (DC power type)
- Self-diagnosis function
(Green LED is lighted in stable level.)
- Reverse power polarity and overcurrent
- Power supply :
Universal 24-240VDC/24-240VAC
- IP66 rated waterproof structure (IEC standard))



※MS-4 is sold separately.

⚠ Please read "Caution for your safety" in operation manual before using.



■ Specifications

● Universal voltage type

Model	Standard type	BX15M-TFR	BX5M-MFR	BX3M-PFR	BX700-DFR
	With Timer	BX15M-TFR-T	BX5M-MFR-T	BX3M-PFR-T	BX700-DFR-T
Sensing type		Transmitted beam	Retroreflective(Standard type)	Retroreflective(polarizing filter)	Diffuse reflective
Sensing distance		15m	(*1) 0.1 ~ 5m(MS-2)	(*2) 0.1 ~ 3m(MS-3)	(*3) 700mm
Sensing target		Opaque materials of Min. ϕ 15mm	Opaque materials of Min. ϕ 60mm		Transparent, Translucent, Opaque material
Hysteresis		—	—		Max. 20% at rated setting distance
Response time		Max. 20ms			
Power supply		24-240VAC \pm 10% 50/60Hz, 24-240VDC \pm 10% (Ripple P-P:Max. 10%)			
Current consumption		Max. 3VA			
Light source		Infrared LED(Modulated)		Red LED(Modulated:660nm)	Infrared LED(Modulated)
Sensitivity adjustment		Adjuster			
Operation mode		Selectable Light ON or Dark ON by slide switch			
Control output		Relay contact output Contact capacity : 30VDC 3A, 250VAC 3A at resistive load, Contact composition: 1c(SPDT)			
Relay life cycle		Mechanically : Min. 50,000,000, Electrically : Min. 100,000			
Self-diagnosis output		Green LED turns on at unstable operation			
Timer function		Selectable ON Delay, OFF Delay, One Shot Delay by slide switch [Delay Time : 0.1 ~ 5sec (VR adjustable)]			
Indicator		Operation indicator : Yellow LED, Self-diagnosis indicator : Green LED			
Connection		Terminal connection			
Insulation resistance		Min. 20M Ω (at 500VDC mega)			
Insulation type		Double insulation			
Noise strength		\pm 1,000V the square wave noise (pulse width:1 μ s) by the noise simulator			
Dielectric strength		1500VAC 50/60Hz for 1minute			
Impulse dielectric strength		1kV (Generator : 1.2/50 μ s, Source impedance : 500 Ω , Source energy : 0.5J)			
Vibration	Mechanical	1.5mm amplitude at frequency of 10 ~ 55Hz in each of X, Y, Z directions for 2 hours			
	Malfuntn	1.5mm amplitude at frequency of 10 ~ 55Hz in each of X, Y, Z directions for 10 minutes			
Shock	Mechanical	500m/s ² (50G) in X, Y, Z directions for 3 times			
	Malfuntn	100m/s ² (10G) in X, Y, Z directions for 3 times			
Ambient illumination		Sunlight : Max. 11,000lx, Incandescent lamp : Max. 3,000lx			
Ambient temperature		-20 ~ +65 $^{\circ}$ C (at non-freezing status), Storage : -25 ~ +70 $^{\circ}$ C			
Ambient humidity		35 ~ 85%RH, Storage : 35 ~ 85%RH			
Protection		IP66 (IEC standard)			
Material		Case : ABS, Lens : Acrylic			
Accessory	Individual	—	Reflector(MS-2)	Reflector(MS-3)	—
	Common	Adjustment driver, Fixing bracket, Bolts/Nuts			
Approval		CE			
Unit weight		TFR : Approx. 198g, TFR-T : Approx. 203g	MFR : Approx. 126g, MFR-T : Approx. 131g	PFR : Approx. 130g, PFR-T : Approx. 134g	DFR : Approx. 110g, DFR-T : Approx. 115g

※ **(*1)** It is same when MS-4 is used and it is able to detect under 0.1m.

※ **(*2)** MS-2 is used, sensing distance will be 0.1~2m, it is able to detect under 0.1m.

※ **(*3)** It is for Non-glossy white paper(200 \times 200mm)

Universal Voltage with Built-in Amplifier(Terminal type)

■ Specifications

● DC power type

Model	Standard type	BX15M-TDT	BX5M-MDT	BX3M-PDT	BX700-DDT
	With Timer	BX15M-TDT-T	BX5M-MDT-T	BX3M-PDT-T	BX700-DDT-T
Sensing type	Transmitted beam		Retroreflective (Standard type)	Retroreflective (Polarizing filter)	Diffuse reflective
Sensing distance	15m		(*1) 0.1 ~ 5m(MS-2)	(*2) 0.1 ~ 3m(MS-3)	(*3) 700mm
Sensing target	Opaque materials of Min. ϕ 15mm		Opaque materials of Min. ϕ 60mm	Opaque materials of Min. ϕ 60mm	Transparent, Translucent, Opaque material
Hysteresis	—		—	—	Max. 20% at rated setting distance
Response time	Max. 1ms				
Power supply	12-24VDC \pm 10% (Ripple P-P:Max. 10%)				
Current consumption	Max. 40mA		Max. 30mA		
Light source	Infrared LED (Modulated)			Infrared LED (Modulated)	Infrared LED (Modulated)
Sensitivity adjustment	Adjuster				
Operation mode	Selectable Light ON or Dark ON by slide switch				
Control output	<ul style="list-style-type: none"> • NPN open collector output \Rightarrow Load voltage : Max. 30VDC, Load current : Max. 200mA, Residual voltage : Max. 1V at 200mA, Max. 0.4V at 16mA • PNP open collector output (Yellow LED) \Rightarrow Output voltage : Min. power supply-2.5V, Load current : Max. 200mA 				
Self-diagnosis output	NPN open collector output \Rightarrow Load voltage : Max. 30VDC, Load current : Max. 50mA, Residual voltage : Max. 1V at 50mA, Max. 0.4V at 16mA				
Protection circuit	Reverse polarity protection, Overload & short circuit protection				
Timer function	Selectable ON Delay, OFF Delay, One Shot Delay by slide switch [Delay Time : 0.1 ~ 5sec (VR adjustable)]				
Indicator	Operation indicator : Yellow LED, Self-diagnosis indicator : Green LED				
Connection	Terminal connection				
Insulation resistance	Min. 20M Ω (at 500VDC mega)				
Noise strength	\pm 240V the square wave noise (pulse width:1 μ s) by the noise simulator				
Dielectric strength	1000VAC 50/60Hz for 1minute				
Vibration	1.5mm amplitude at frequency of 10 ~ 55Hz in each of X, Y, Z directions for 2 hours				
Shock	500m/s ² (50G) in X, Y, Z directions for 3 times				
Ambient illumination	Sunlight : Max. 11,000lx, Incandescent lamp : Max. 3,000lx				
Ambient temperature	-20 ~ +65 $^{\circ}$ C (at non-freezing status), Storage : -25 ~ +70 $^{\circ}$ C				
Ambient humidity	35 ~ 85%RH, Storage : 35 ~ 85%RH				
Protection	IP66 (IEC standard)				
Material	Case : ABS, Lens cover : Acrylic, Lens : Acryl				
Accessory	Individual	—	Reflector (MS-2)	Reflector (MS-3)	—
	Common	Adjustment driver, Fixing bracket, Bolts/Nuts			
Approval	CE				
Unit weight	Approx. 212g		Approx. 124g	Approx. 142g	Approx. 117g

※ **(*1)** It is same when MS-4 is used and it is able to detect under 0.1m.

※ **(*2)** MS-2 is used, sensing distance will be 0.1~2m, it is able to detect under 0.1m.

※ **(*3)** It is for Non-glossy white paper(200 \times 200mm).

(A) Counter

(B) Timer

(C) Temp. controller

(D) Power controller

(E) Panel meter

(F) Tacho/Speed/Pulse meter

(G) Display unit

(H) Sensor controller

(I) Switching power supply

(J) Proximity sensor

(K) Photo electric sensor

(L) Pressure sensor

(M) Rotary encoder

(N) Stepping motor & Driver & Controller

(O) Graphic panel

(P) Production stoppage models & replacement

BX Series

Feature data

Transmitted beam

- BX15M-TFR / BX15M-TFR-T
- BX15M-TDT / BX15M-TDT-T

Diffuse reflective

- BX700-DFR / BX700-DFR-T
- BX700-DDT / BX700-DDT-T

Parallel shifting characteristic		Angle Characteristic		Sensing area	
Measuring method	Data	Measuring method	Data	Measuring method	Data

Retroreflective

- BX5M-MFR / BX5M-MFR-T
- BX5M-MDT / BX5M-MDT-T

Parallel shifting characteristic		Sensor angle characteristic		Reflector angle characteristic	
Measuring method	Data	Measuring method	Data	Measuring method	Data

Polarized retroreflective

- BX3M-PFR / BX3M-PFR-T
- BX3M-PDT / BX3M-PDT-T

Parallel shifting characteristic		Sensor angle characteristic		Reflector angle characteristic	
Measuring method	Data	Measuring method	Data	Measuring method	Data

Universal Voltage with Built-in Amplifier(Terminal type)

Control output diagram

☉ Universal voltage

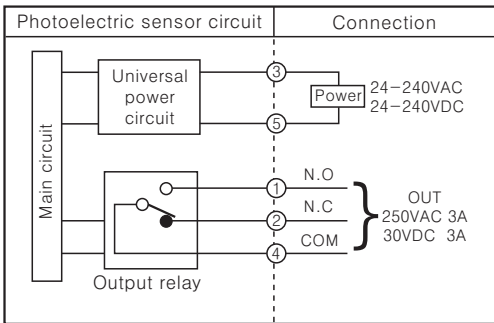

☉ DC voltage

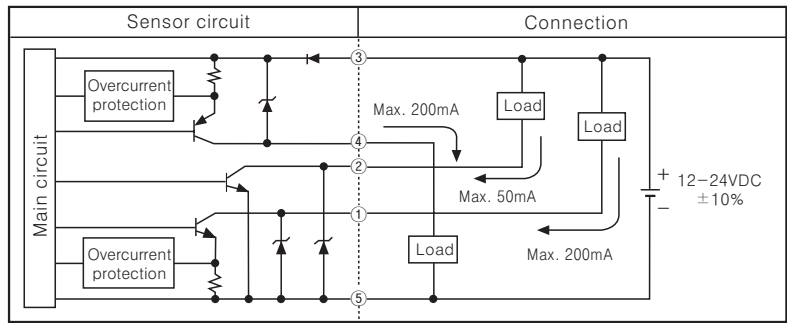

※In case of product with the output protection device, if terminals of control output are short-circuited or overcurrent condition is existed, the control output will turn off due to protection circuit.

Operation mode and timing diagram

● Light ON mode

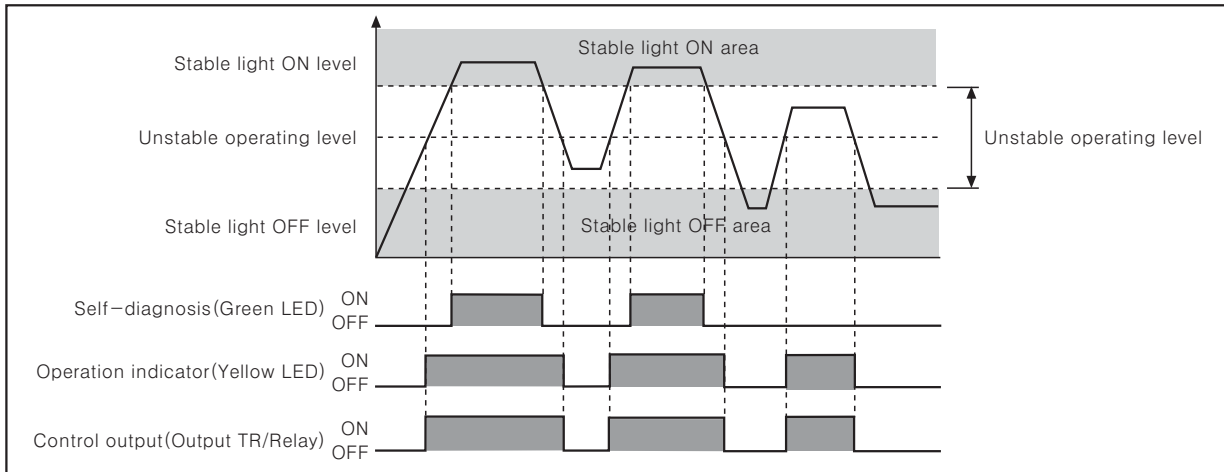

※Operation for Dark ON mode is opposed to above chart indication for Light ON mode.

※To prevent from the misoperation, output of units keeps the state of OFF for 0.5sec. after power ON.

Timer mode

Timer mode	Switch position		Status of light Operation mode	OUT (Control output)	Timing diagram
	S1	S2			
NORMAL MODE	ON	ON	Light ON	ON	[Timing diagram: Pulse ON, then OFF]
			Dark ON	OFF	[Timing diagram: Pulse OFF, then ON]
ONE SHOT DELAY MODE	ON	OFF	Light ON	ON	[Timing diagram: Pulse ON with delay T, then OFF]
			Dark ON	OFF	[Timing diagram: Pulse OFF with delay T, then ON]
ON DELAY MODE	OFF	ON	Light ON	OFF	[Timing diagram: Delay T, then pulse ON]
			Dark ON	ON	[Timing diagram: Delay T, then pulse OFF]
OFF DELAY MODE	OFF	OFF	Light ON	ON	[Timing diagram: Pulse ON with delay T, then OFF]
			Dark ON	OFF	[Timing diagram: Delay T, then pulse OFF]

※T : Time set by timer adjuster.

(A) Counter

(B) Timer

(C) Temp. controller

(D) Power controller

(E) Panel meter

(F) Tacho/Speed/Pulse meter

(G) Display unit

(H) Sensor controller

(I) Switching power supply

(J) Proximity sensor

(K) Photo electric sensor

(L) Pressure sensor

(M) Rotary encoder

(N) Stepping motor & Driver & Controller

(O) Graphic panel

(P) Production stoppage models & replacement

BX Series

Connections

Transmitted beam

●BX15M-TFR1

●BX15M-TFR 2,
BX15M-TFR-T2

●BX15M-TDT1

●BX15M-TDT2,
BX15M-TDT-T2

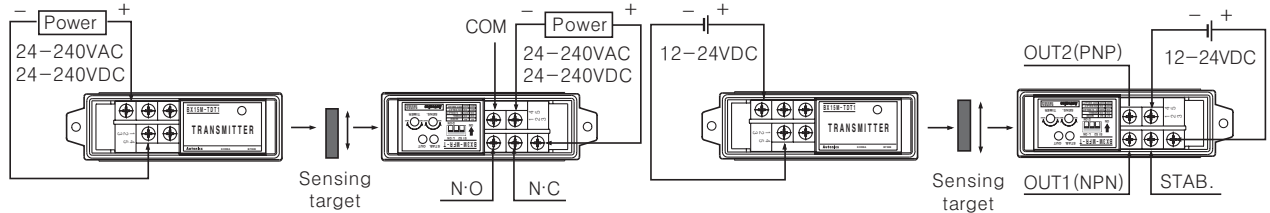

Retroreflective / Retroreflective with polarizing filter

●BX5M-MFR, BX5M-MFR-T
●BX3M-PFR, BX3M-PFR-T

●BX5M-MDT, BX5M-MDT-T
●BX3M-PDT, BX3M-PDT-T

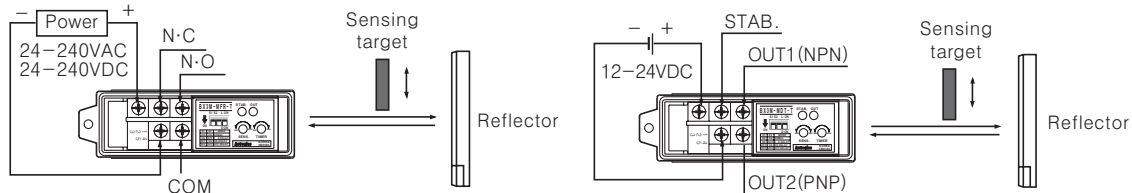

Diffuse reflective

●BX700-DFR, BX700-DFR-T

●BX700-DDT, BX700-DDT-T

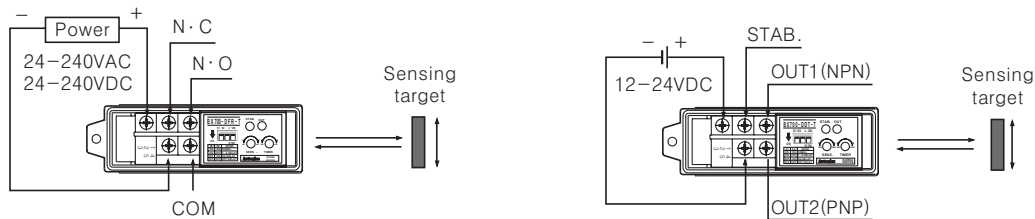

Cable

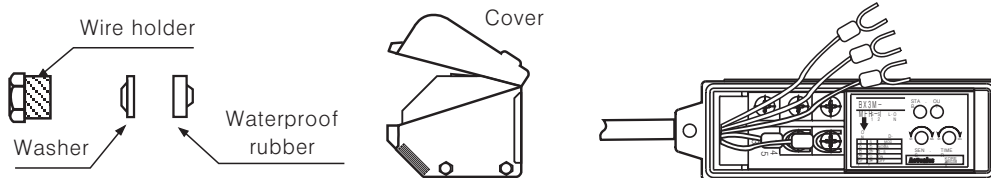
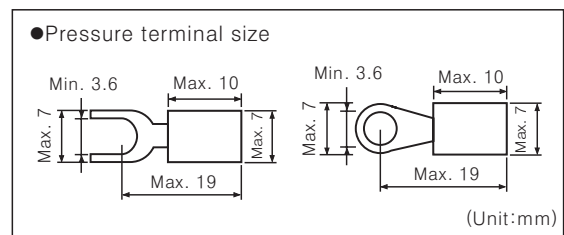
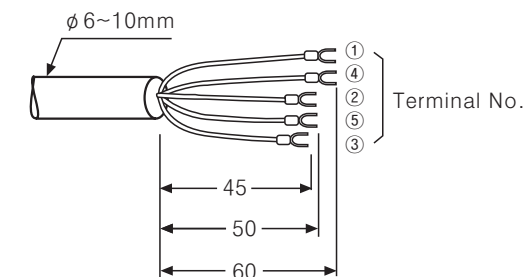

※ On servicing wire, connect wire on terminal as above figure.

※ Select the round wire with the size of $\phi 6 \sim 10\text{mm}$ for the waterproof and tighten the cable holder by torque of 1.0 to $1.5\text{N} \cdot \text{m}$.

※ On servicing wire, tighten screw of terminals by torque of $0.8\text{N} \cdot \text{m}$.

※ On mounting the cover, tighten the cover nut by torque of $0.3 \sim 0.5\text{N} \cdot \text{m}$.

Universal Voltage with Built-in Amplifier(Terminal type)

Front panel identification

○Transmitted beam

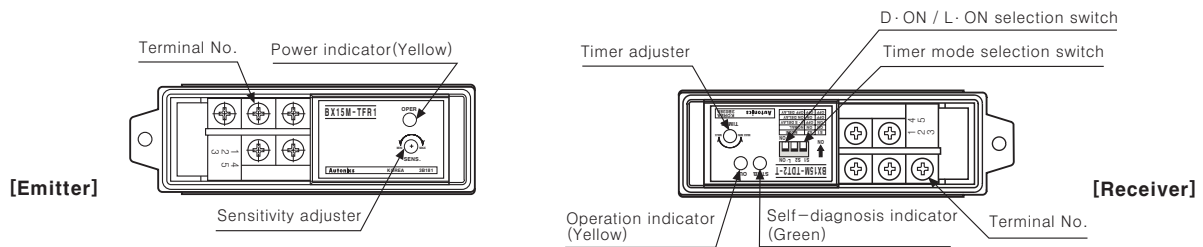

○Retroreflective / Retroreflective with polarizing filter ○Diffuse reflective

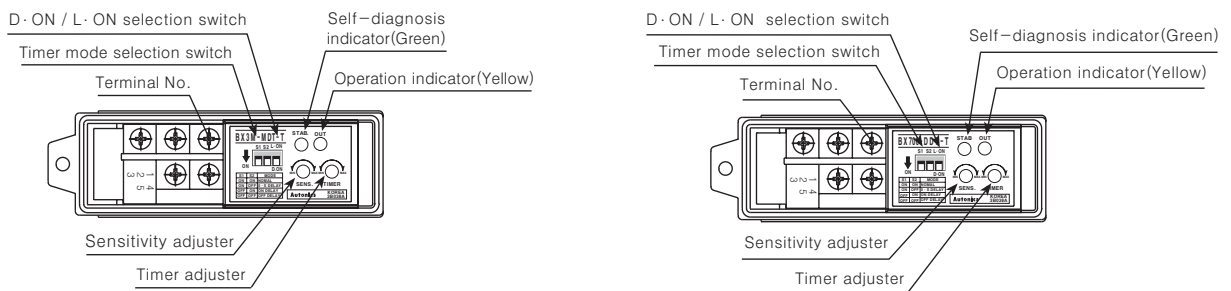

※There are no Timer mode selection switch and Timer adjuster in type without Timer function.

Dimensions

(Unit:mm)

●Product

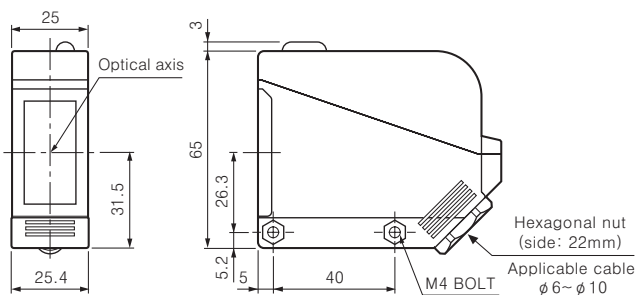
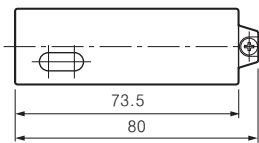

●Bracket

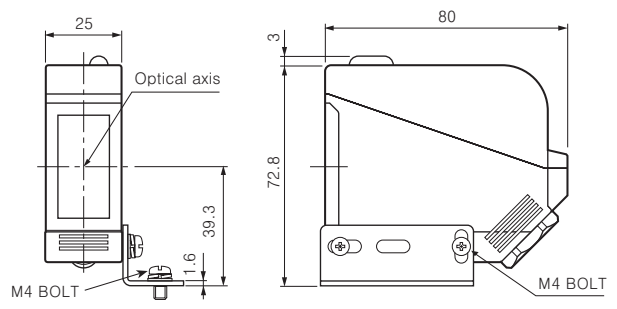
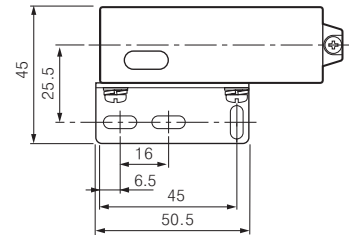

●Bracket

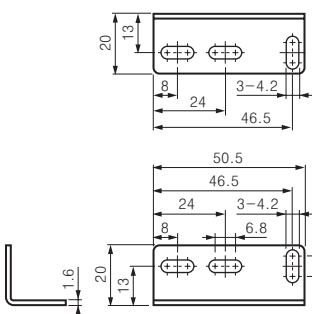

●Reflector

• MS-2

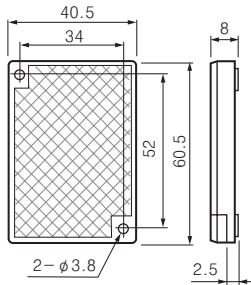

• MS-3

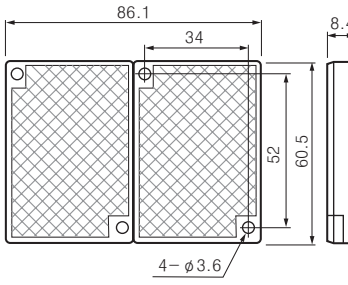

• MS-4

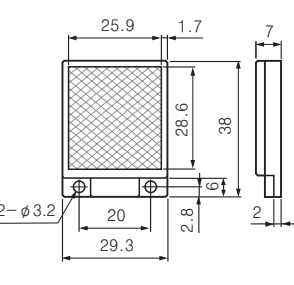

(A) Counter

(B) Timer

(C) Temp. controller

(D) Power controller

(E) Panel meter

(F) Tacho/Speed/Pulse meter

(G) Display unit

(H) Sensor controller

(I) Switching power supply

(J) Proximity sensor

(K) Photo electric sensor

(L) Pressure sensor

(M) Rotary encoder

(N) Stepping motor & Driver & Controller

(O) Graphic panel

(P) Production stoppage models & replacement

BX Series

■ Mounting and sensitivity adjustment

○ Transmitted beam type

1. Supply the power to the photoelectric sensor, after set the emitter and the receiver facing each other.
2. Set the receiver in center of position in the middle of the operation range of indicator adjusting the receiver or the emitter right and left, up and down.
3. Adjust up and down direction as the same.
4. After adjustment, check the stability of operation putting the object at the optical axis.

※ If the sensing target is translucent body or smaller than $\phi 15\text{mm}$, it can be missed by sensor cause light penetrate it.

※ Sensitivity adjustment : Please see the diffuse reflective type.

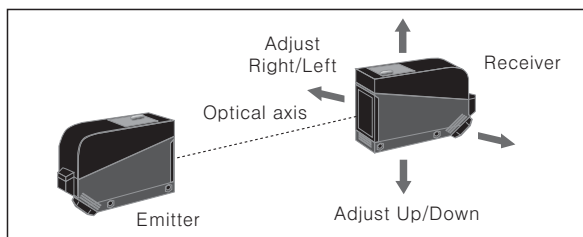

○ Diffuse reflective type

1. The sensitivity should be adjusted depending on a sensing target or mountin place.
2. Set the target at a position and turn sensitivity adjuster from minimum sensitivity position slowly, confirm position ㉑ in the middle of the operation range of indicator and self diagnosis indicator (Green LED) is OFF.
3. If turn adjuster higher slowly in state of removed target, the operation indicator (Yellow LED) will be OFF and self diagnosis indicator (Green LED) will be ON. Confirm this position as ㉒.
[When self diagnosis indicator (Green LED) and operation indicator (Yellow LED) are OFF, the Max. sensitivity position will be ㉒.]
4. Set the adjuster at the center of two switching position ㉑, ㉒.

※ Above sensitivity adjustment is when it is the state of Light ON mode. If it is the state of Dark ON mode, operation indicator (Yellow LED) will be opposite.

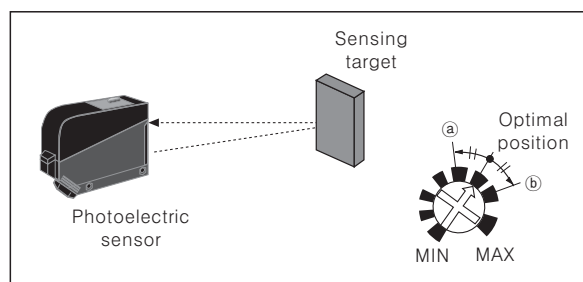

※ The sensing distance indicated on specification chart is against $200 \times 200\text{mm}$ of non-glossy white paper. Be sure that it can be different by size, surface and gloss of target.

○ Retroreflective type

1. Supply the power to the photoelectric sensor, after set the photoelectric sensor and the reflector (MS-2) facing each other.
2. Set the photoelectric sensor in the middle of the operation range of indicator adjusting the reflector or the sensor right and left, up and down.
3. Adjust up and down direction as the same.
4. After adjustment, check the stability of operation putting the object at the optical axis.

※ If use more than 2 photoelectric sensors in parallel, the space between them should be more than 30cm.

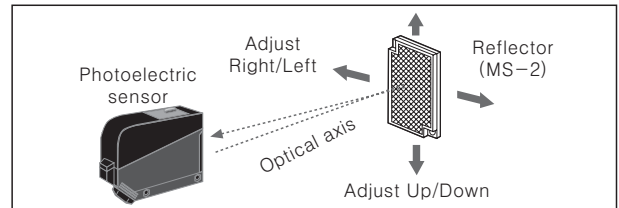

※ If use more than 2 photoelectric sensors in parallel, the space between them should be more than 30cm.

※ If reflectance of target is higher than non-glossy white paper, it might cause malfunction by reflection from the target when the target is near to photo sensor. Therefore put enough space between the target and photoelectric sensor or the surface of target should be installed at an angle of $30^\circ \sim 45^\circ$ against optical axis. (When detecting target with high reflectance near by, photoelectric sensor with the polarizing filter should be used.)

※ Sensitivity adjustment : Please refer to the diffuse reflective type.

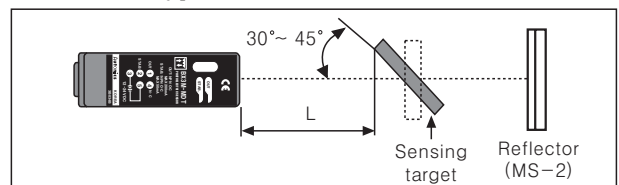

※ If the mounting place is too small, please use MS-4 instead of MS-2 for same sensing distance.

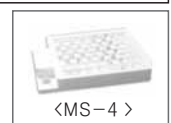

○ Retroreflective type (With polarizing filter)

The light passed through the polarizing filter of emitter reaches to MS-3 converting as horizontal direction, it reaches to photodetector through the filter of receiver converting as vertical by MS-3 function. Even it can detect normal mirror.

